

The MYLAR with 7.0mm length is for 2P or 3P products

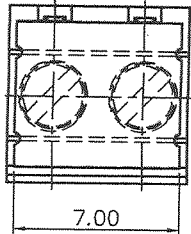

The MYLAR with 14.0mm length is for products of more than 4P

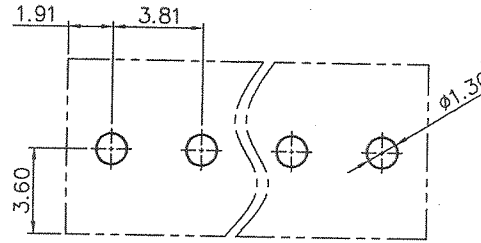
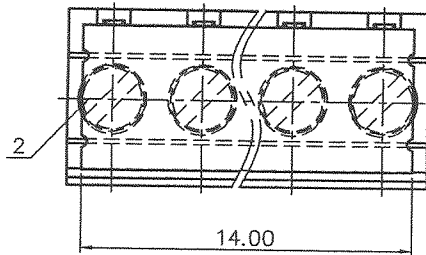

P.C.B LAYOUT

REVISION RECORD				
REV	ECN	DESCRIPTION	DRFT	DATE
(T0-2)		Plastic material PA4T change for Thermoplastic	Jay.z	11/08/16*

NOTES1:

- UL Standard
- 1. Rated voltage/current : 150V / 10A
- 2. Withstanding voltage : AC1300V/1Min.
- 3. Torque value : M2 , 1.77Lb.in
- 4. Wire range : 30~16AWG

IEC Standard

1. Pollution degree	2	2	3
Overvoltage category	II	III	III
Rate impulse voltage(KV)	2.5KV	2.5KV	2.5KV
Rate voltage(V)	200V	200V	63V
Rate current(A)	13.5A		

- 2. Torque value : M2 , 0.2N·m
- 3. Wire range : 0.2~1.5mm²

NOTES2:

- 1. Dimension shall be interpreted per ASME Y14.5-2009
- 2. Pitch : 3.81mm, Poles : N=02~08P
- 3. Stripping length : 5~6mm
- 4. Operating temperature: -40°C~+130°C
- 5. Undimensioned tolerances:

Pitch range in mm		Nominal dimension range in mm				-	∩	∇
TO	Over	TO	Over	TO	Over	TO	Over	TO
6	10	30	60	100	150			0.1/10
±0.15	±0.20	±0.30	±0.50	±0.70	±1.00	±1.30	±2'	<

6. RoHS Compliance

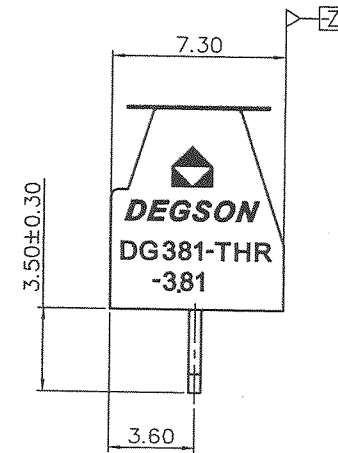
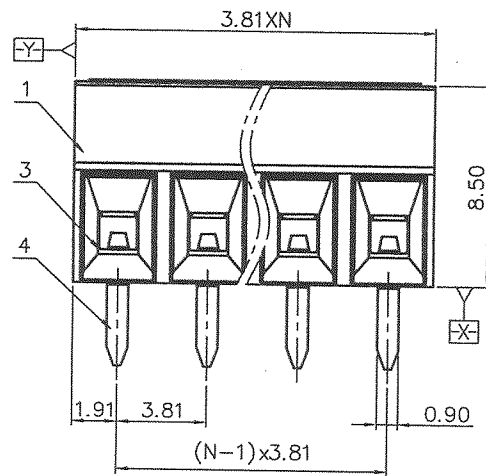
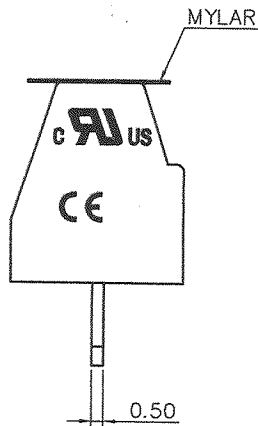

DG381-THR - 3.81 - XXP - 1Y - 00A (H)

(Series No.) (Pitch) (Poles) (Single Pitch) (Color)

(RoHS)
00A--(Standard)
1.(Grey)
2.(Blue)
3.(Black)
4.(Green)
5.(Orange)
6.(Red)
7.(Transparent)
8.(Yellow)
9.(White)

5	Tape	Kapton	
4	Pin header	Copper alloy	Sn Plated
3	Cage	Copper alloy	M2/Ni Plated
2	Screw	Steel	M2/Zn Plated
1	Housing	Thermoplastic	UL94V-0
ITEM	NAME OF PART	MATERIAL	NOTES

PART NO.: /		NINGBO DEGSON ELECTRICAL CO., LTD	
APPD: Aaron 1/14/17		NAME: DG381-THR-3.81-XXP-1Y-00A(H)	
CHKD: Jay.z 1/14/17		TITLE: CUSTOMER DRAWING	
DRFT: Jay.z 10/23/14		REV	T0-2
THIRD ANGLE PROJECTION		DRAWING NO.: DG381-THR-3.81-C01	SHEET 1/3
		DO NOT SCALE DRAWING	SCALE 1:1

REVISION RECORD				
REV	ECN	DESCRIPTION	DRFT	DATE
(10-2)		Drawing update	Jay.z	01/14/17

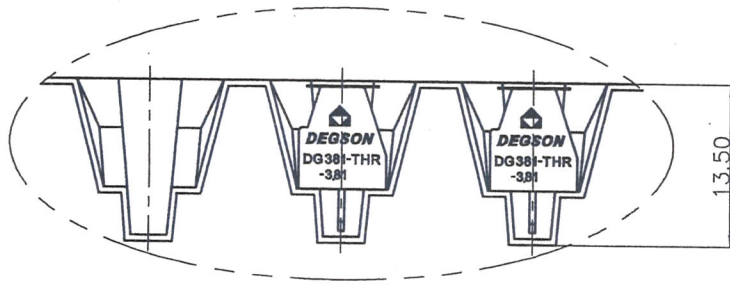
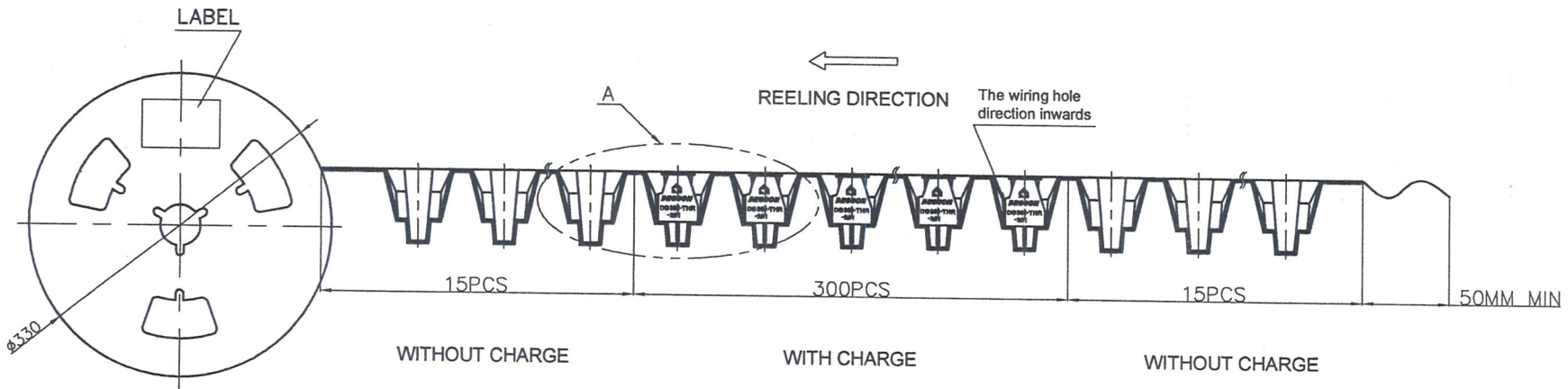
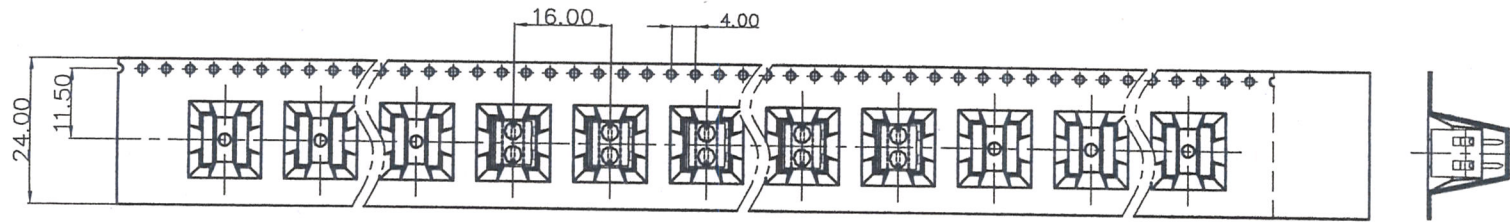

Detail A
(2:1)

试量产专用
 (仅限内部使用, 对外无效)

DG381-THR-3.81-02P 卷带	2P	24mm	16mm
REEL NAME	POLE	WIDTH	PICH

DETACHED LISTS	PART NO.: /	宁波高松电子有限公司 NINGBO DEGSON ELECTRICAL CO., LTD		
	APPD: <i>Amor/15-17</i>	NAME: DG381-THR-3.81-02P-1Y-00A(H)		
	CHKD: <i>Jay.z 01/14/17</i>	TITLE: ASSEMBLY DRAWING		
	DRFT: Jay.z 01/31/15	REV: T0-2	SHEET: 2/3	
THIRD ANGLE PROJECTION		DRAWING NO.: DG381-THR-3.81-C01	DO NOT SCALE DRAWING	SCALE: 1:1

REVISION RECORD				
REV	ECN	DESCRIPTION	DRFT	DATE
(T0-2)		Packaging direction update	Jay.z	01/14/17"

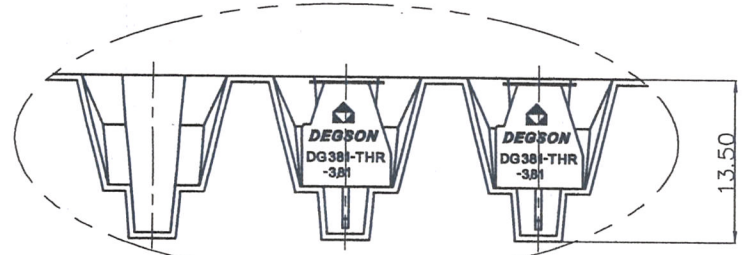
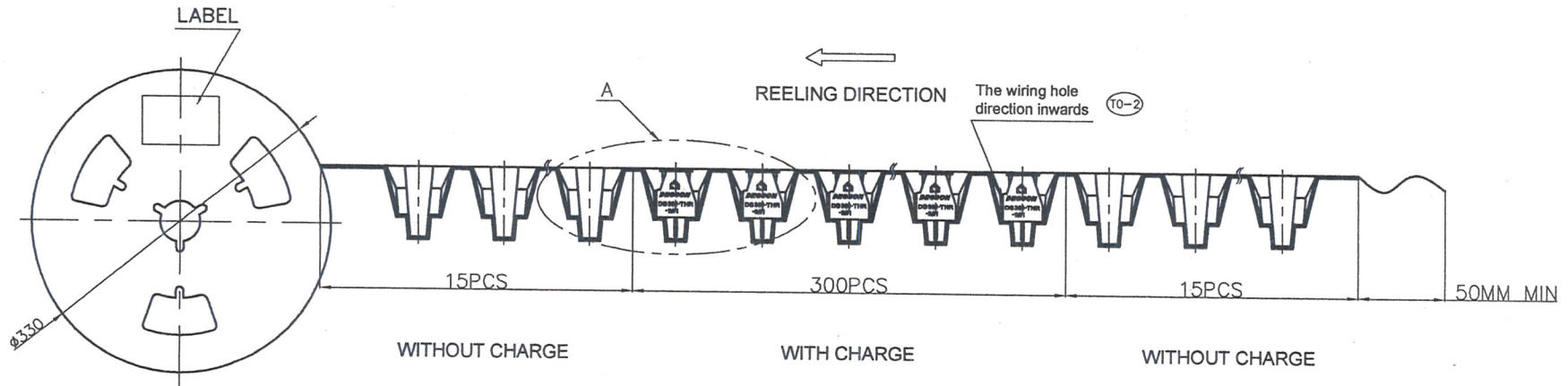
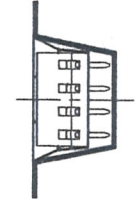
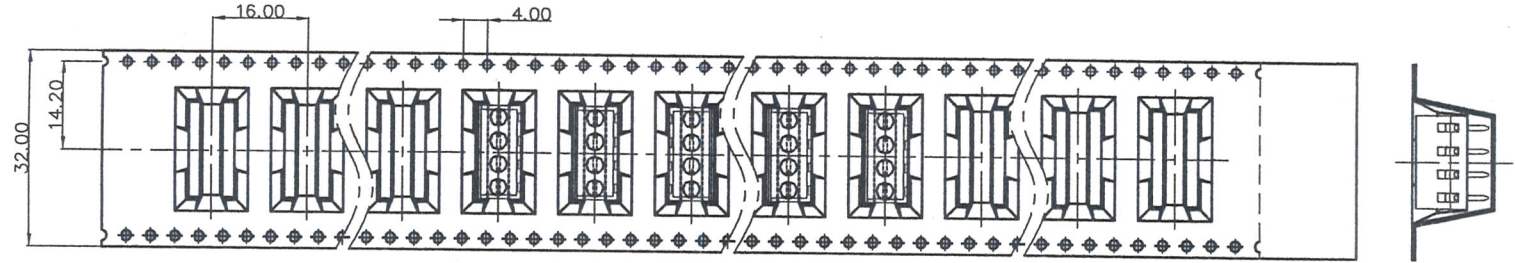

Detail A
(2:1)

试量产专用
成数同其组

DG381-THR-3.81-04P 卷带	4P	32mm	16mm
REEL NAME	POLE	WIDTH	PICH

DETACHED LISTS	PART NO.: /	宁波高松电子有限公司 NINGBO DEGSON ELECTRICAL CO., LTD		
	APPD: <i>Aaron 1/15/17</i>	NAME: DG381-THR-3.81-04P-1Y-00A(H)		
	CHKD: <i>Jay.z 01/14/17"</i>	TITLE: ASSEMBLY DRAWING		
	DRFT: <i>Jay.z 01/31/15"</i>	DRAWING NO.: DG381-THR-3.81-C01	REV	T0-2
	 THIRD ANGLE PROJECTION	 DO NOT SCALE DRAWING	SHEET	3/3
	SCALE	1:1		